

Centro Theatre Set 1, 3 and 4

Assembly Instructions

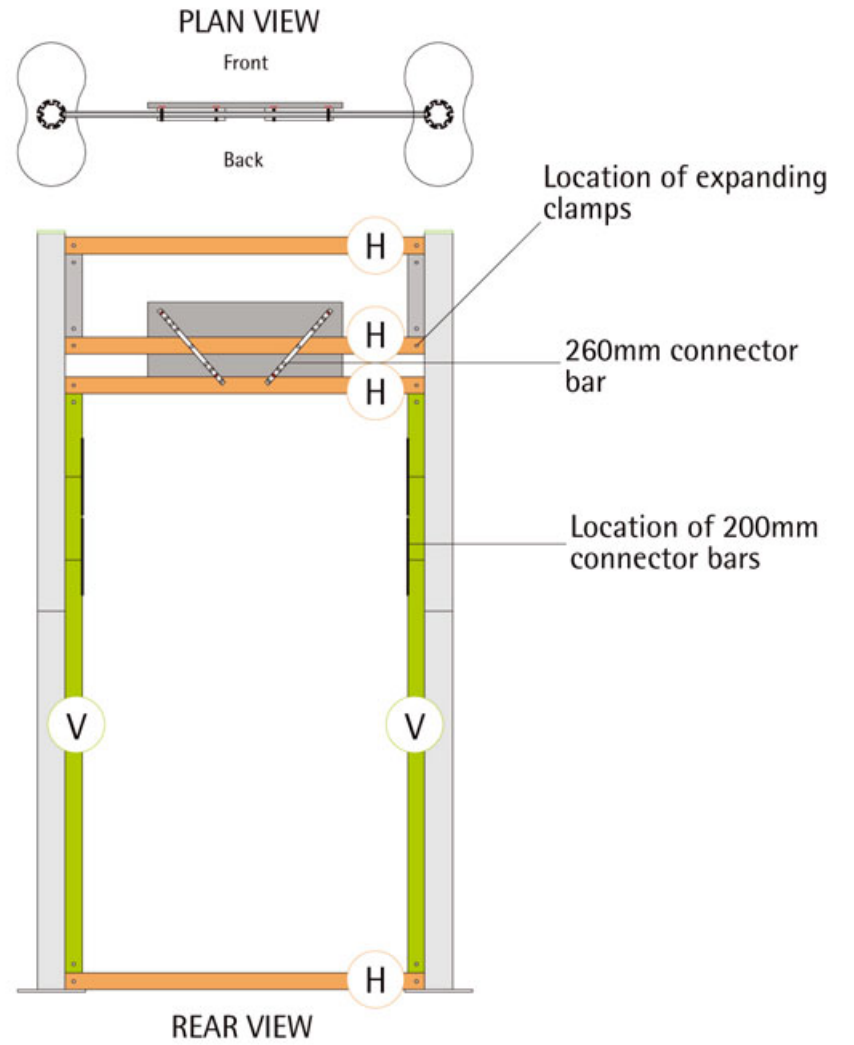

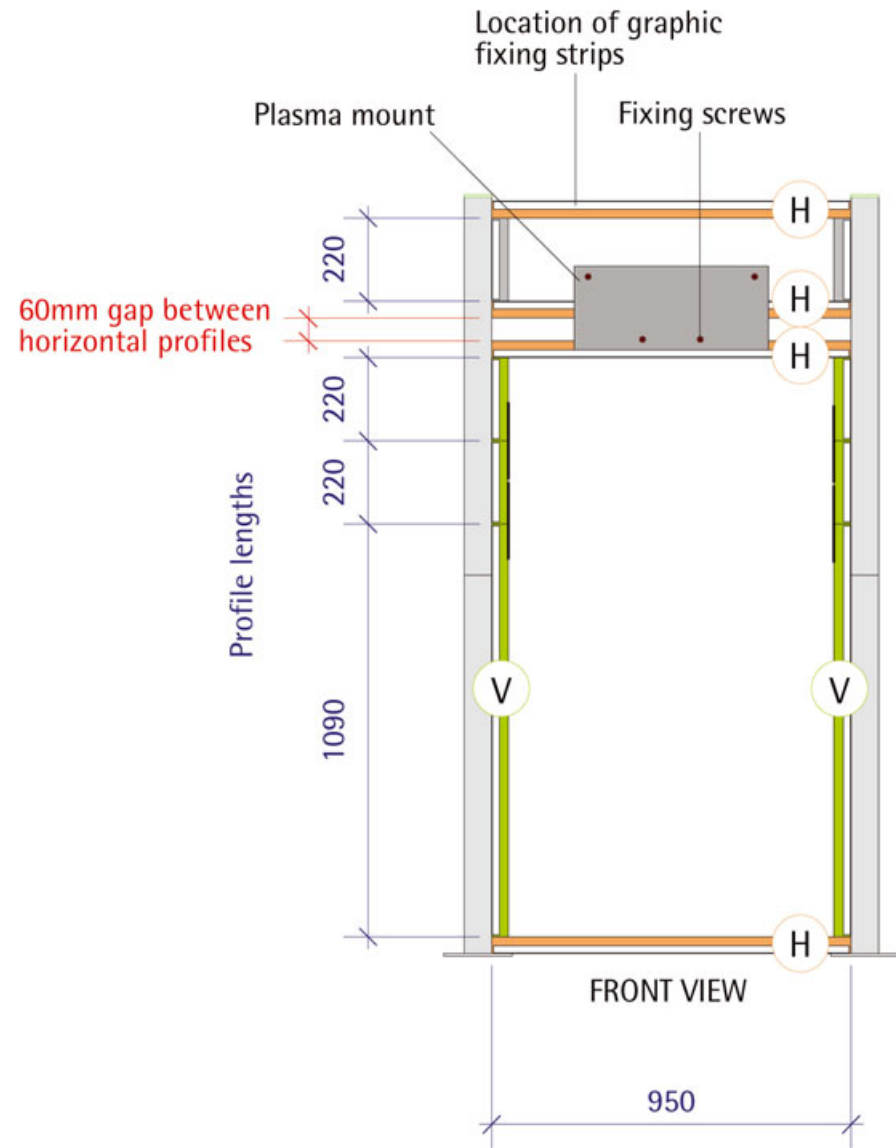

1



Stand base assembly on the ground. Loosen grub screws and slide both connector bars half way out of channel and retighten. Repeat for other base assembly.



2



Align acrylic cap notches in upper 8-way post assembly with protruding connectors at stage 1.



3

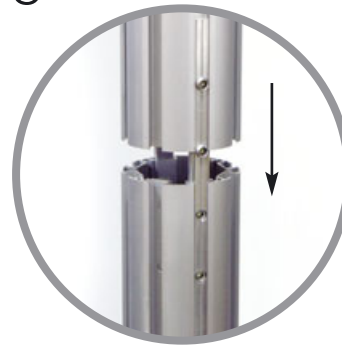

Fully join posts and tighten remaining grub screws to make assembly secure. Repeat for other base post.

4.1

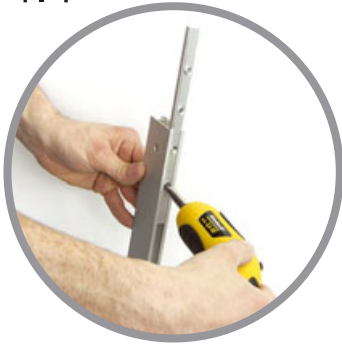

4.2.1

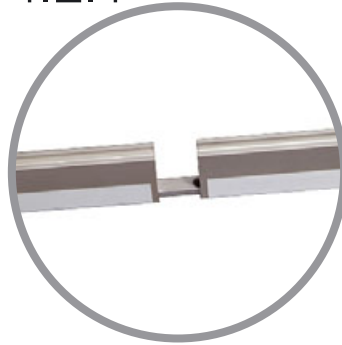

4.2.2

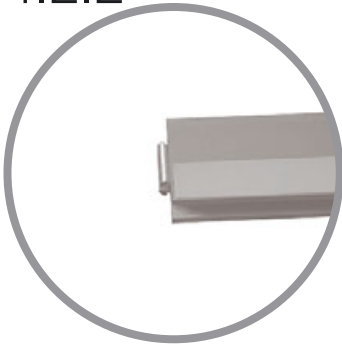

4.3



The vertical (V) frame profiles are joined in a similar manner to the posts.

4.1) Loosen grub screws and slide connector bars halfway out of the channel.

4.2) Join profiles ensuring graphic fixing strips are aligned and the expanding clamps are at either end of the assembled profiles.

4.3) Tighten grub screws to make secure.

5.1

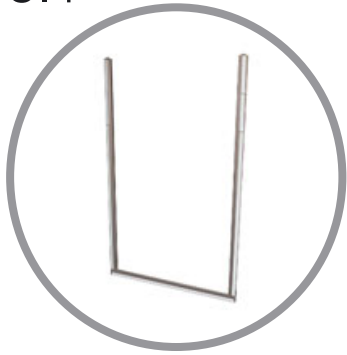

5.2



Connect two vertical (V) 1531mm assembly rails at 90° to each end of the 950mm horizontal rail (H) ensuring that the graphic fixing strip is outermost all round and the verticals are flush with the end of the 950mm rail. Tighten both bottom grub screws in expanding clamps on verticals to secure to horizontal.



6.1



6.2



Connect second 950mm horizontal (H), using the expanding clamps, to top of assembled verticals (V and V) ensuring that the graphic fixing strip is at the bottom. Tighten grub screws on vertical rails to secure. This completes the bottom section of the framework.



7.1

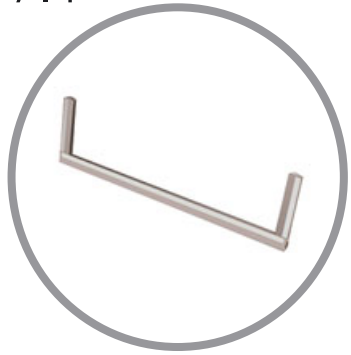

7.2



For the top section of the framework, connect the two 220mm profiles, with expanding clamps at both ends and the single fixing strip, at 90° flush to each end of the third 950mm horizontal rail (H). Ensure that the graphic fixing strip on the verticals are outermost and the graphic fixing strip on the horizontal 950mm rail is at the top. Tighten lower grub screws adjacent to horizontal rail assembly to secure 220mm verticals.



8.1

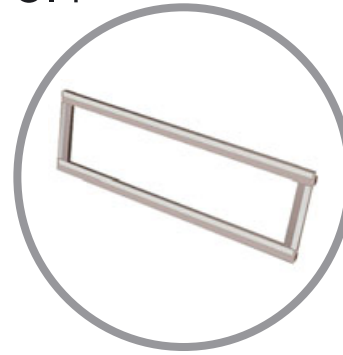

8.2



Slot final top horizontal 950mm rail (H) to the 220mm verticals, ensuring that the graphic fixing strip is at the top. Tighten grub screws on verticals to secure framework. This completes the top section of the framework.



9.1



9.2



Slot the bottom section framework into the channel of the assembled post at 90° to the base plate. Ensure framework is resting on the base plate and graphic fixing strip is adjacent to the floor. Tighten both grub screws in the horizontals (H) to secure to post assembly.



10.1



10.2



Affix the top section framework into the same channel as the bottom section ensuring graphic fixing strips are all on the same side of the system. Leave a gap of 60mm in between bottom and top framework assemblies and tighten all grub screws in horizontals (H) to secure to post.



11.1

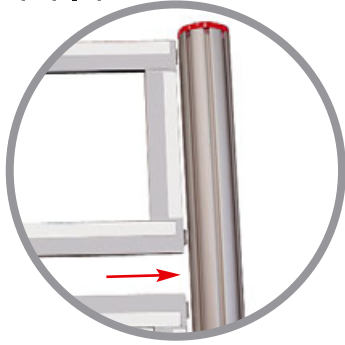

11.2



11.3



11.4



Slot open end of framework into other assembled post, at 90° to the base plate. Ensure bottom section rests on base plate and top section is 60mm above lower framework section. Tighten remaining grub screws in horizontals (H) to secure assembly.



12.1



12.2



Prepare and cut aperture in graphic according to the graphic spec appropriate to the desired screen size. Apply magnetic tape to rear of graphic panel in locations shown on graphic spec and affix completed panel to framework.



13

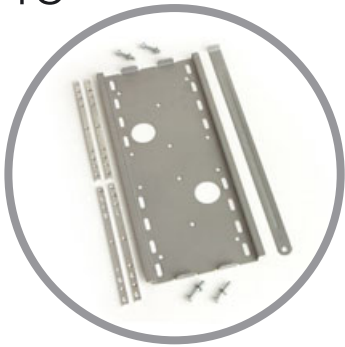

Unpack the LCD/Plasma Screen Mounting Bracket, 4 off 260mm connector bars, and 4 suitable screws and washers to thread into connector bars.

14.1



14.2

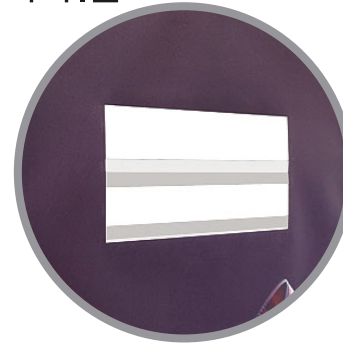

14.3

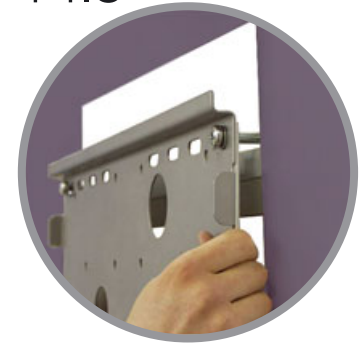

14.4



Insert 2 screws through upper corner mount holes as shown and clearance holes in 2 off connector bars. Position mount centrally over upper horizontal rail in aperture and screw (not fully) into other 2 off 260mm connector bars, situated on the other side of the horizontal rail, to hold in position.



15.1



15.2



15.3



Raise screen mount so bottom holes are above the lower horizontal rail in aperture. Insert remaining 2 screws through lower mount holes (4 openings from either end of the screen mount) and clearance holes in 2 off 260mm connector bars adjacent to mount.

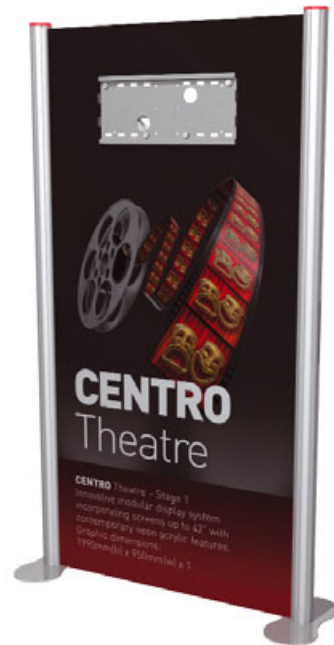

16.1



16.2



Align other 2 off 260mm connector bars, located behind horizontal rails, and screw into threaded holes. Ensure bottom screws rest on lower horizontal rail, mount is in centre of aperture, and tighten all 4 screws to secure assembly.



17



With the elongated holes on the mounting arms uppermost, align arms centrally with 4 off fixing points on rear of screen equidistant from the top. Insert 4 off screws with suitable washers and tighten.

18



Position screen centrally above bracket and lower until top of both mounting arms hook over mount.



19.1



19.2



Slide locking bar between the mounting arms and the plasma mounting bracket if desired. For extra security, there is a facility to add a padlock to the locking bar.

20

To complete Centro Theatre display, please affix additional panels or podium table relevant to the kit ordered.

